







Beginner Music Spelling

NAME THE NOTES TO COMPLETE FEATURE
WORDS FROM ISSUE 1

  
V **T** **R** **N**

  
 RO **TI**

P    

  

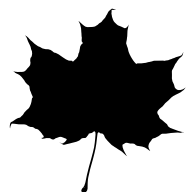

This one is an acronym - Do you know what it stands for?

Connect the Dots

ISSUE 1

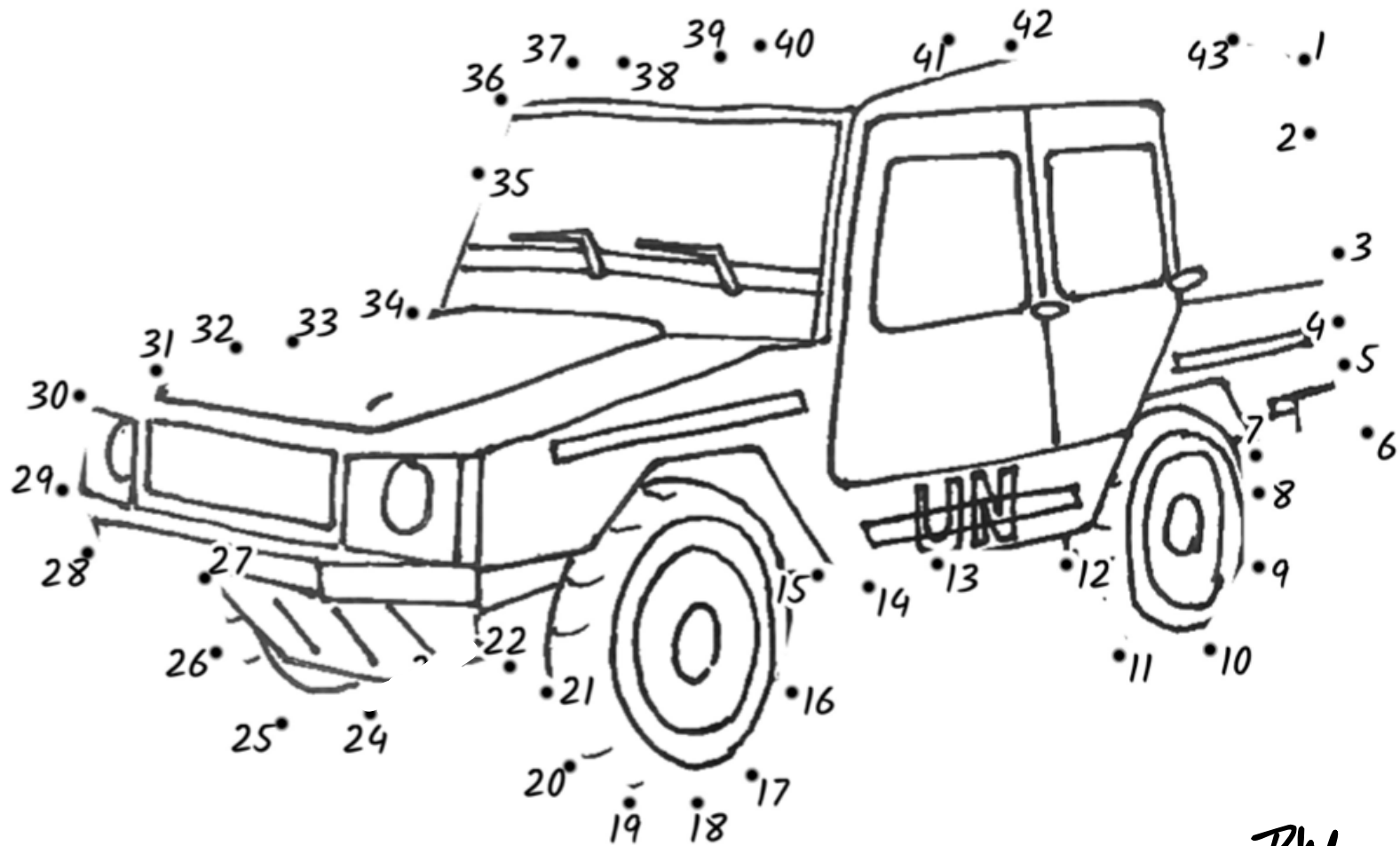

DW

Iltis Jeep

Mini Crossword

ISSUE 1

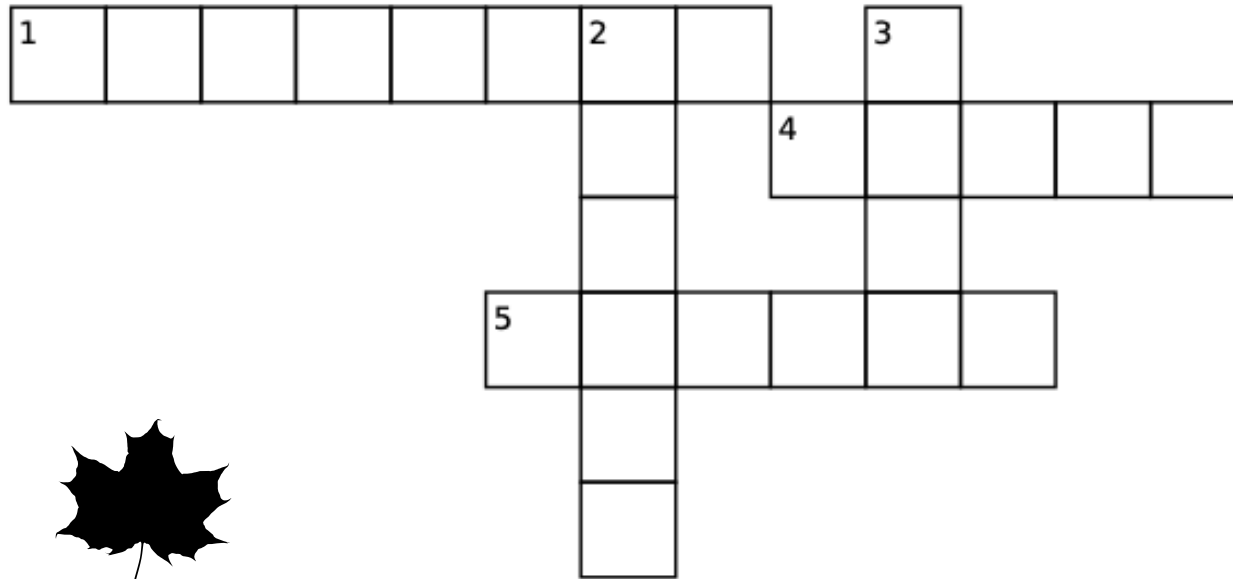

Down:

2. Location of Canada's National Peacekeeping Monument
3. The colour of the helmet and beret worn by peacekeepers.

Across:

1. United Nations Protection Force^{*acronym}
4. Type of Jeep used by Canadian Peacekeepers in the Balkans
5. Capital of Croatia.